

THE VOID

An architect can not create community but The Void can help cultivate it. Located in Southwest Baltimore on West Baltimore Street the site is a key piece to the revitalization of the area. Reaching out to the University of Maryland Bio Park and Downtown to its northeast and James McHenry Elementary and residential community to its southwest, The Void is at a key intersection in the Urban fabric. Utilizing growing, cooking, and eating food as a catalyst The Void seeks to turn vacancy into vibrancy.

The building's public spaces include a courtyard, grand stair, green house, outdoor food vendors, teaching kitchens, restaurants, and retail spaces. To facilitate social interaction among residents, access to shared kitchens, balconies, a gym, and other common spaces was incorporated.

The facades on this courtyard building use a corten steel skin on outward facing elevations and expose steel structure on inward facing elevations to represent a need to look past the facade of the neighborhood and find the community within. Through this articulation and the theme of growth The Void represents the intangible human potential of Baltimore.

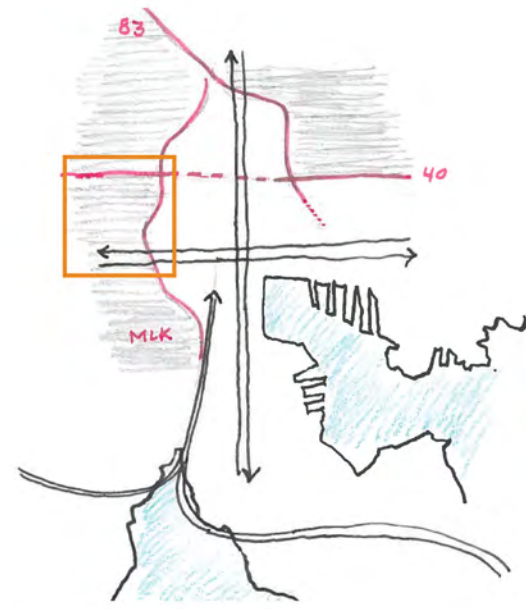

Separation in Baltimore

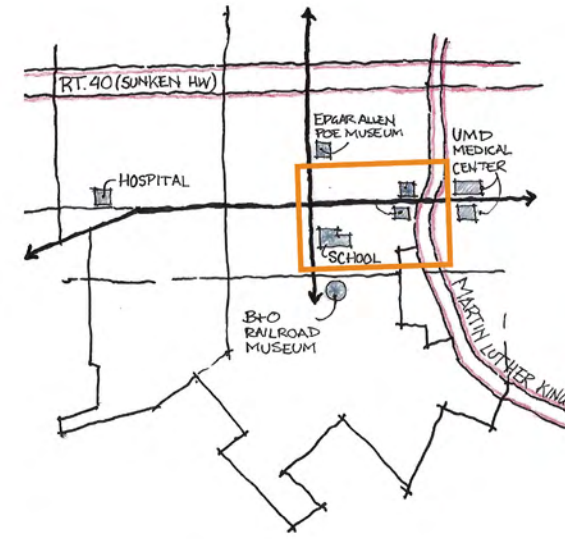

Connection Potential

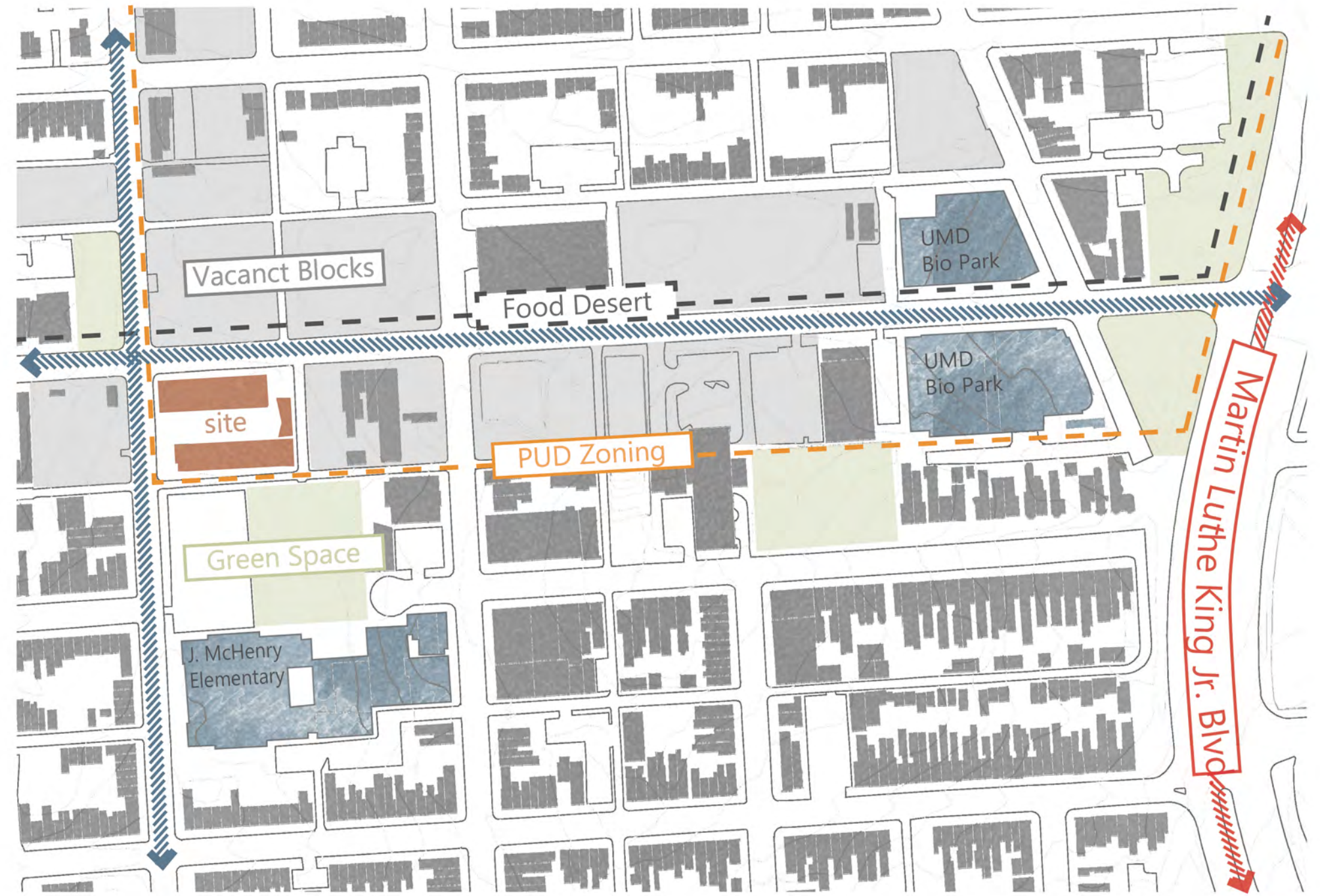

Cornerston Site



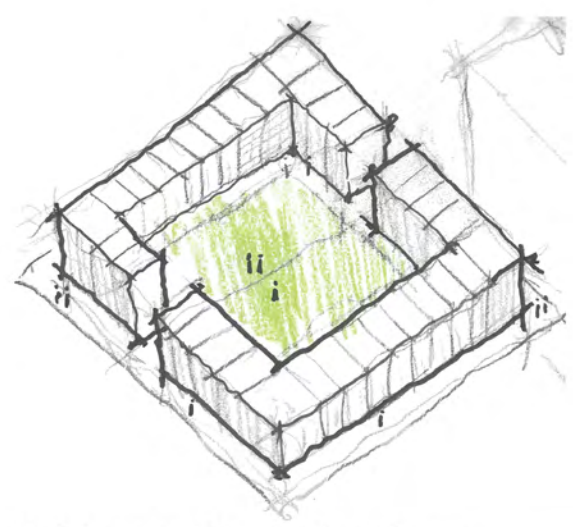

Baltimore Block Typology

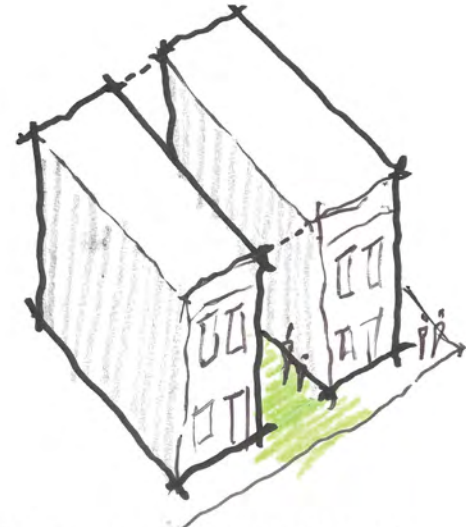

Vacancy = Pocket Park



Social Stoop

=

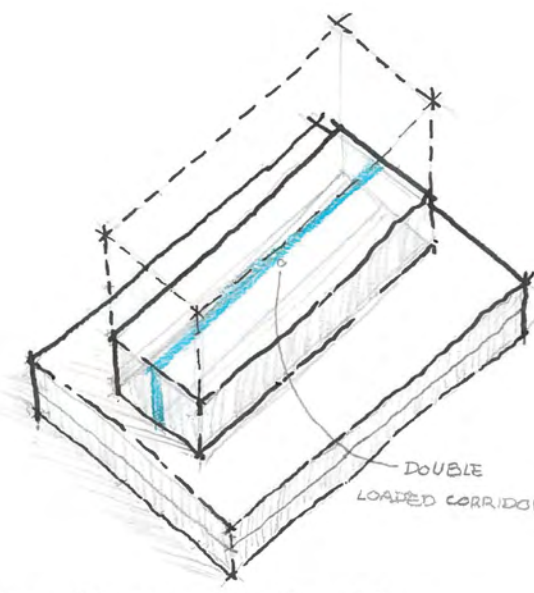

Double Loaded Corridor

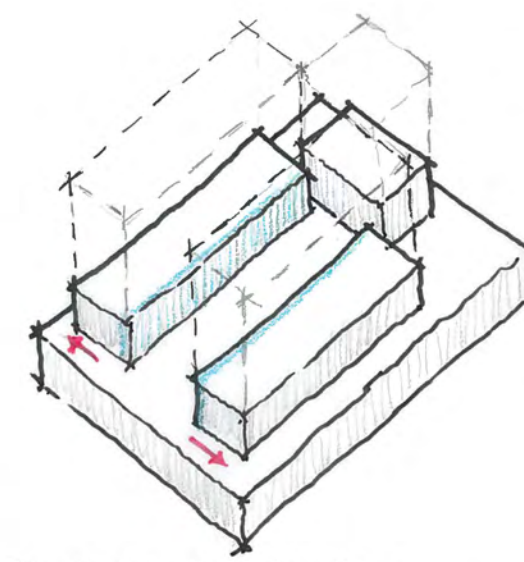

Single Loaded Corridor

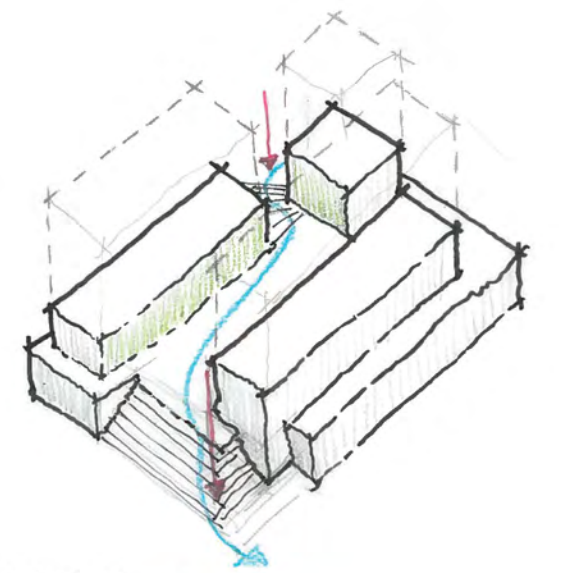

Public Space

Level 1

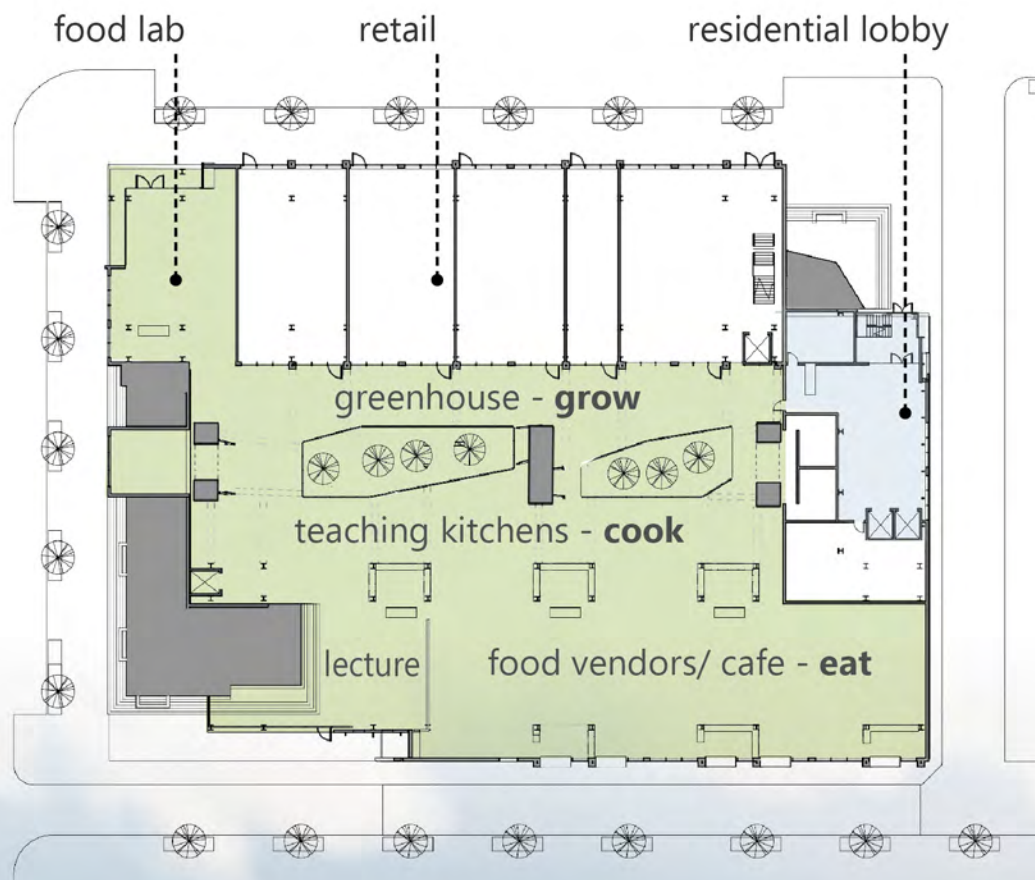

Level 2

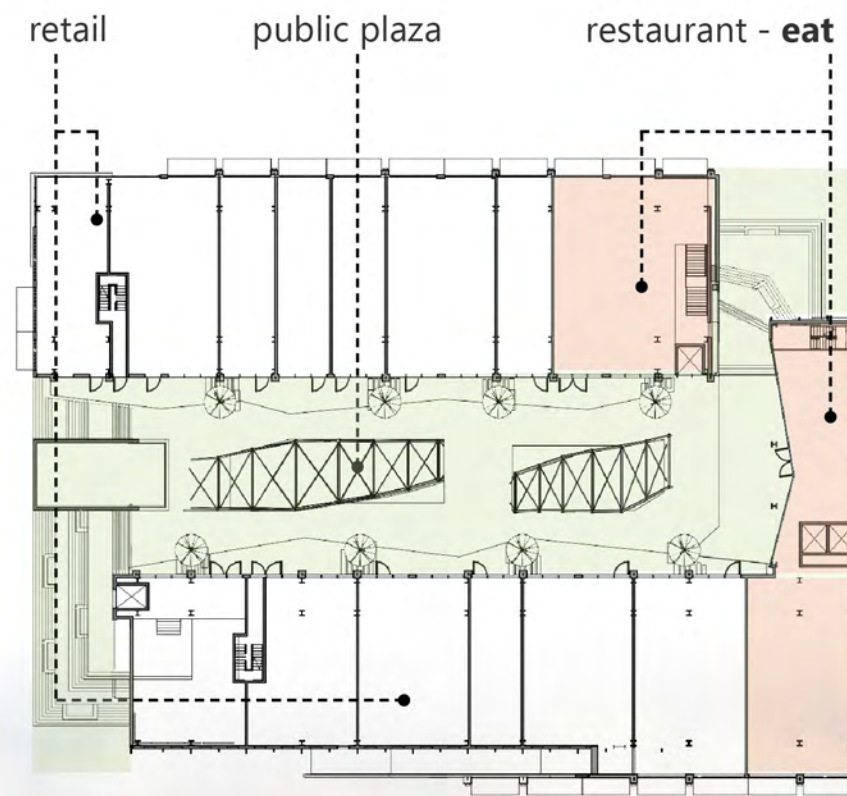

Level 3

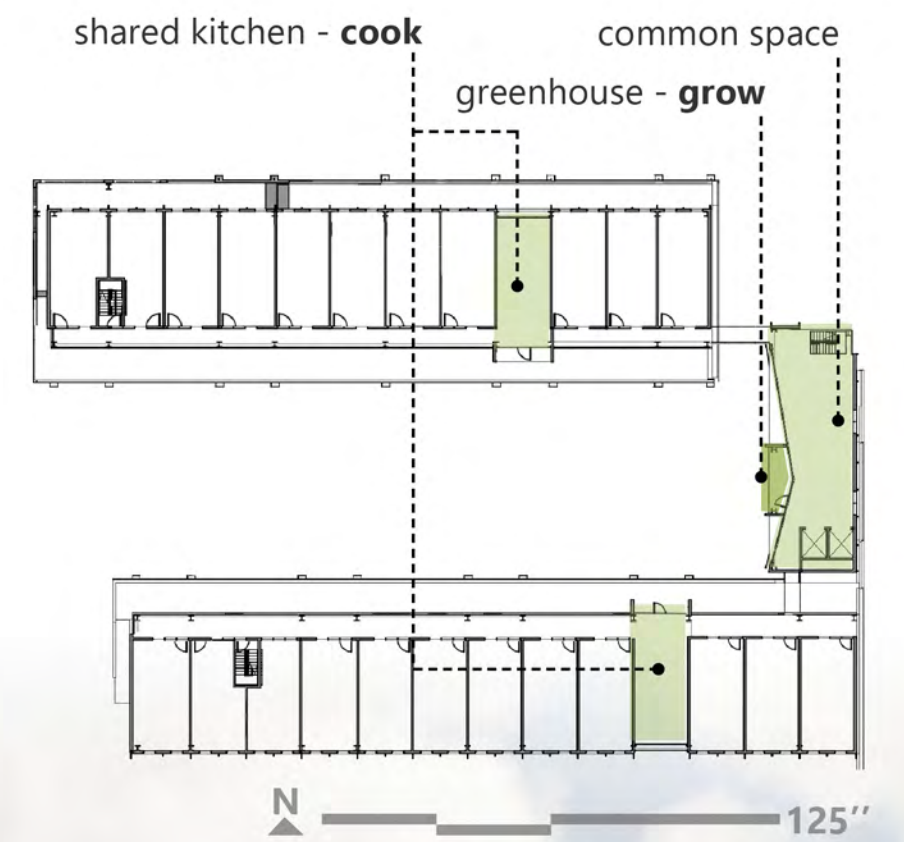



Approach from Bio-Park



Food Lab: Greenhouse and Teaching Kitchens



Food Lab: Outdoor Food Stands

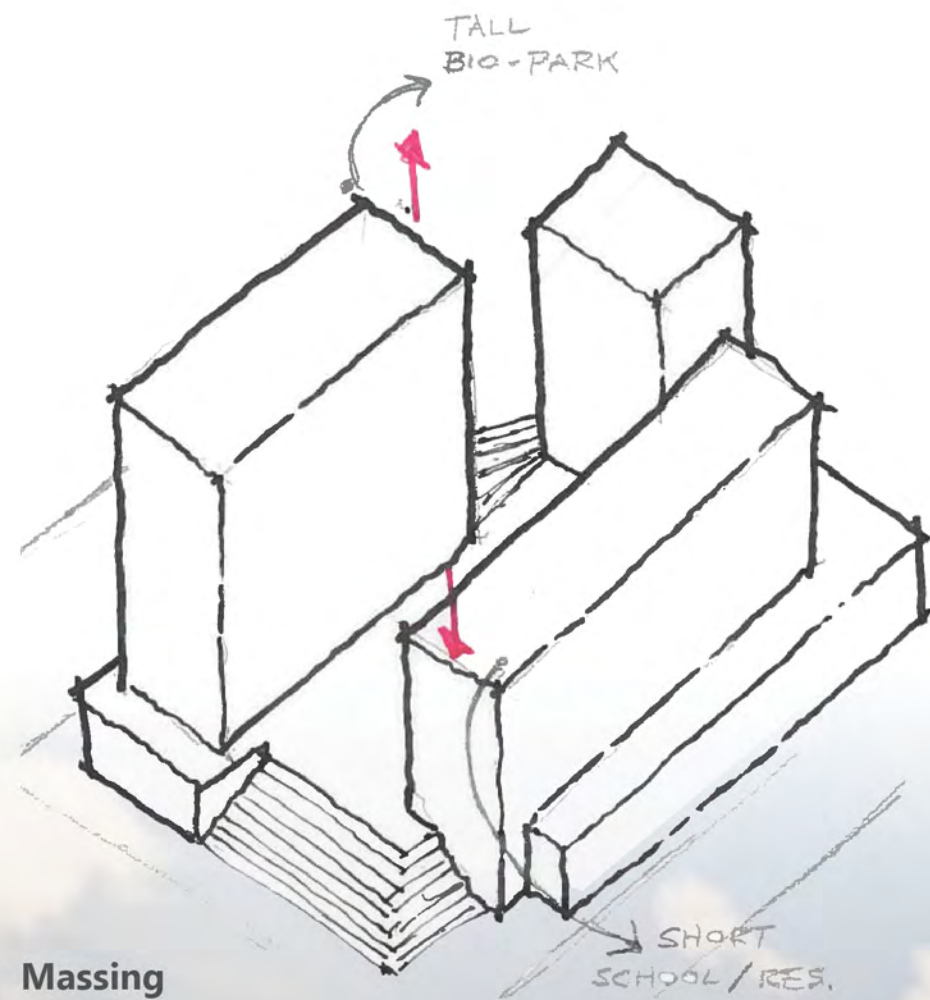

Massing

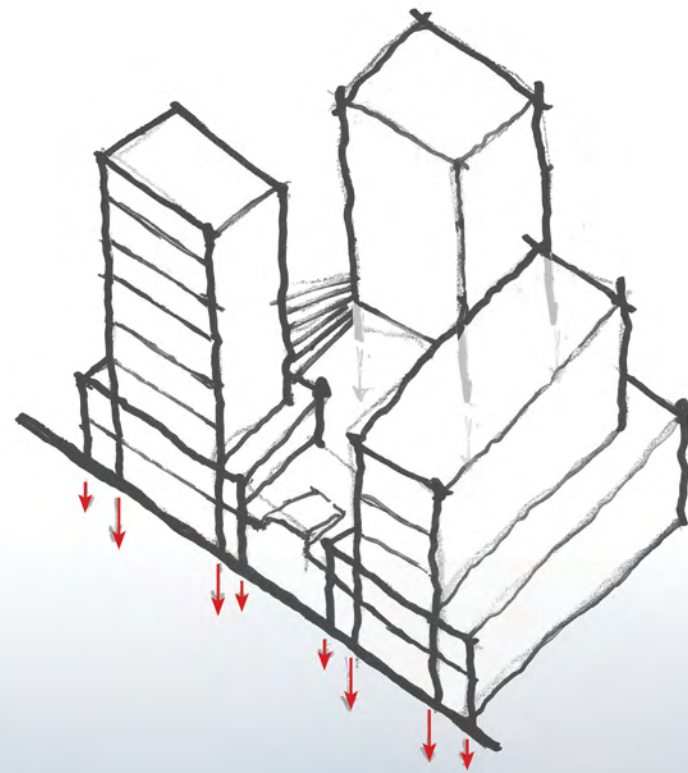

Load Bearing Structure

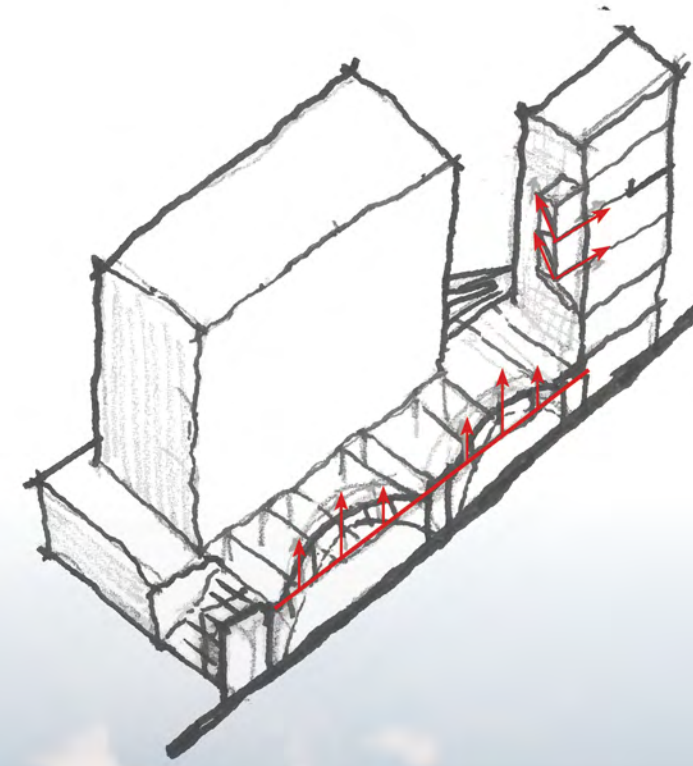

Hanging Structure

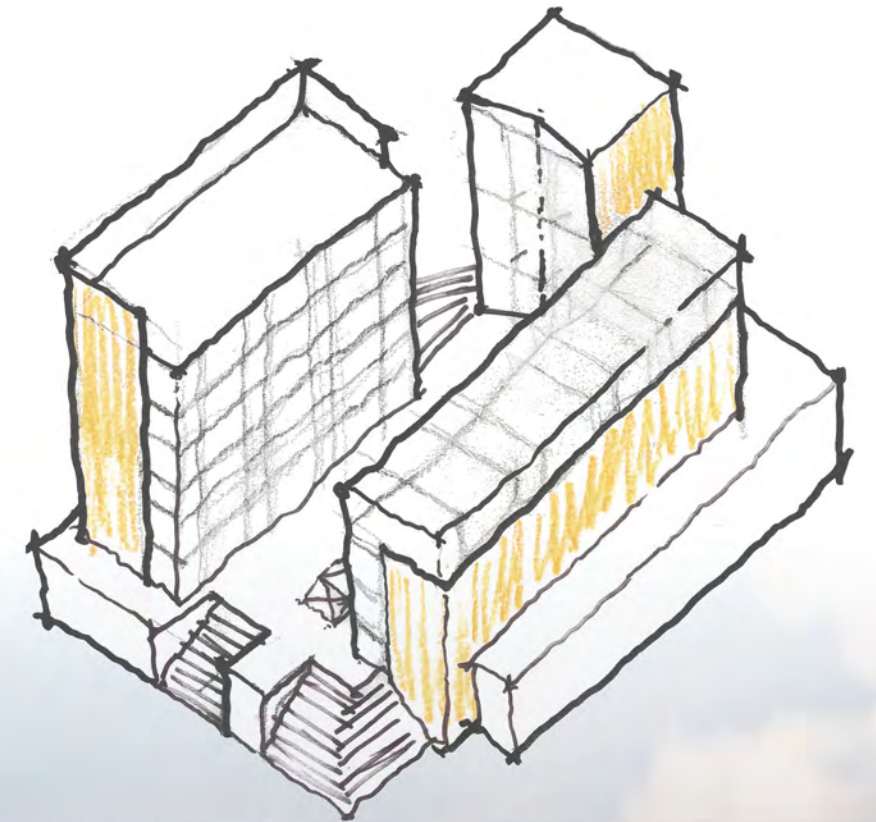

Skin and Bones



gym

common space

common space

restaurant

lobby



Residential Common Space and Greenhouse



Residential Shared Kitchen



Unit Balcony View

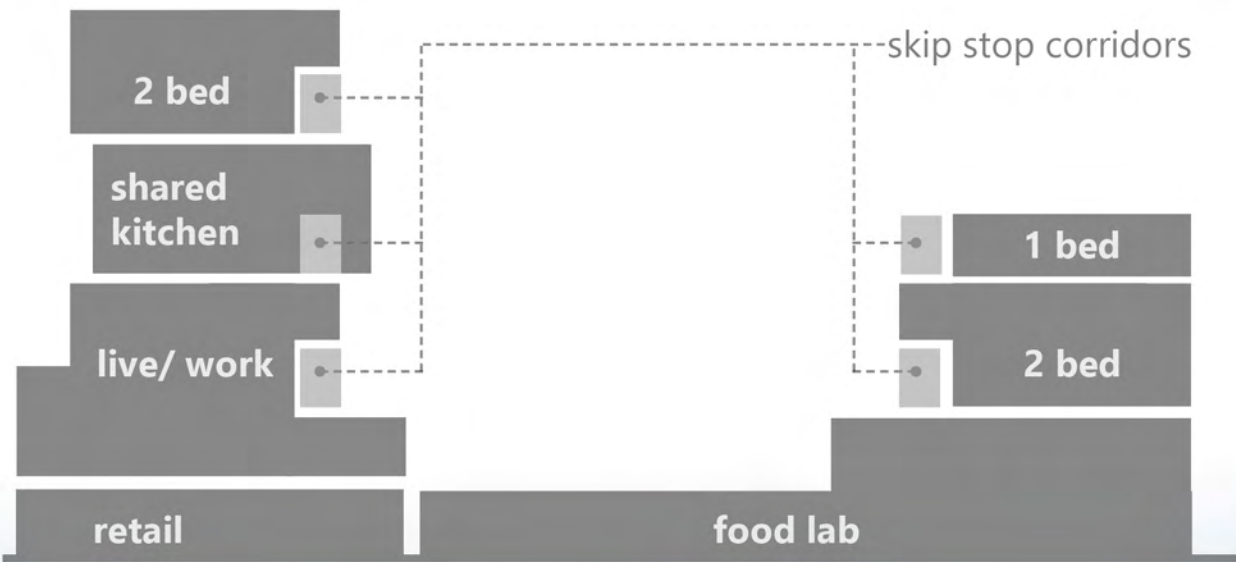

section key



typical unit section

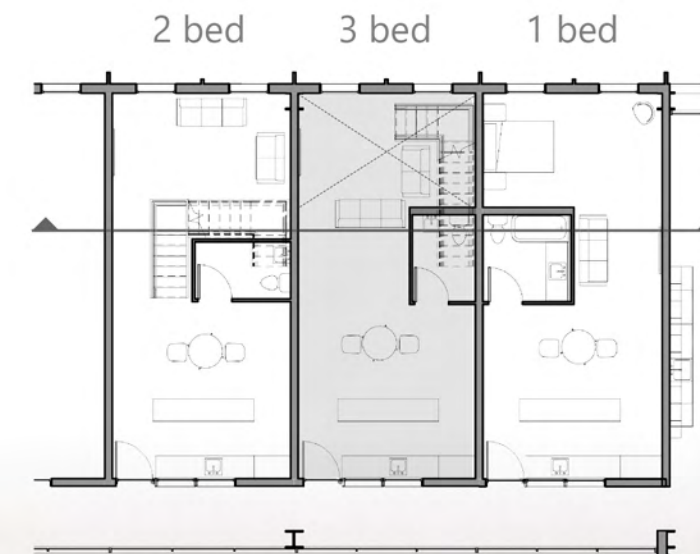

typical corridor level

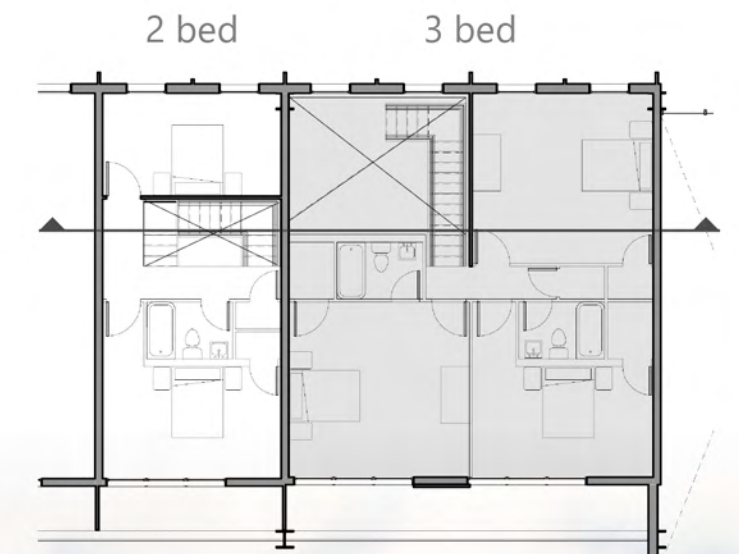

typical balcony level

40'

